

# Data Sheet



Article number: 203260M10100A1S

Description: E+G levelling foot  
GN 32-60-M10-100-A1-S

Note: S Without nut, External hexagon at the bottom

## Measures

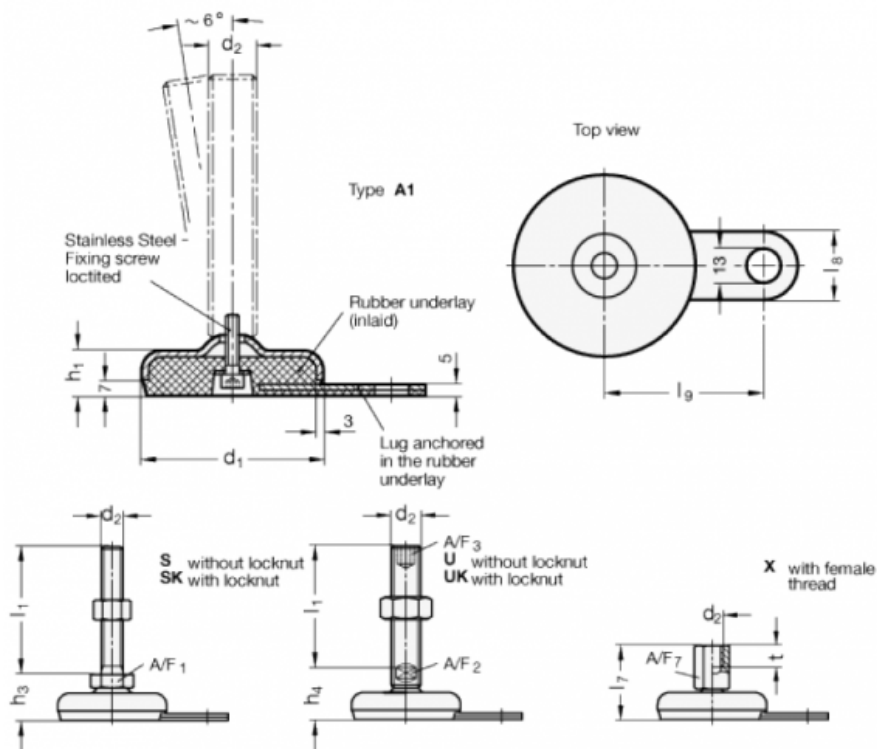

A/F1	=	17
d1	=	60
d2	=	M10
h1	=	19
h3	=	27
l1	=	100
l8	=	25
l9	=	50